



Shenzhen CTA Testing Technology Co., Ltd.
 Room 106, Building 1, Yibaolai Industrial Park, Qiaotou Community, Fuhai Street, Bao'an District, Shenzhen, China

TEST REPORT

Report Reference No......: **CTA24082301102**

Compiled by
 (position+printed name+signature)....: File administrators Jinghua Xiao

Supervised by
 (position+printed name+signature)....: Project Engineer Xudong Zhang

Approved by
 (position+printed name+signature)....: RF Manager Eric Wang



Eric Wang

Date of issue.....: Aug. 30, 2024

Testing Laboratory Name: **Shenzhen CTA Testing Technology Co., Ltd.**

Address.....: Room 106, Building 1, Yibaolai Industrial Park, Qiaotou Community, Fuhai Street, Bao'an District, Shenzhen, China

Applicant's name.....: **Η εταιρεία Κ. ΜΙΧΟΣ και ΣΙΑ Ο.Ε.**

Address.....: Chalandriou Str. 5, Ag. Paraskevi Athens 15343, Greece

Test specification :

Standard.....: **ETSI EN 301 489-1 V2.2.3 (2019-11)**
ETSI EN 301 489-9 V2.1.1 (2019-04)
EN 55032:2015+A11:2020
EN 55035:2017+A11:2020
EN IEC 61000-3-2:2019/A2:2024
EN 61000-3-3:2013/A2:2021/AC:2022

Shenzhen CTA Testing Technology Co., Ltd. All rights reserved.

This publication may be reproduced in whole or in part for non-commercial purposes as long as the Shenzhen CTA Testing Technology Co., Ltd. is acknowledged as copyright owner and source of the material. Shenzhen CTA Testing Technology Co., Ltd. takes no responsibility for and will not assume liability for damages resulting from the reader's interpretation of the reproduced material due to its placement and context.

Test item description: **UHF wireless microphone**

Trade Mark: GILBORD

Manufacturer: Η εταιρεία Κ. ΜΙΧΟΣ και ΣΙΑ Ο.Ε.

Model/Type reference.....: WRL848+WRLM-18

Listed Models: WRL838TDV+WRLM-10, WRL858+WRLM-11, WRL718+WRLM-12, WRL728+WRLM-13, WRL738+WRLM-14, WRL868instr+WRLM-15, WRL750+WRLM-16, REC850+LA-12 TROLLEY MIC, WRL838+WRLM-17

Modulation: FM

Frequency.....: 660.3-690.0MHz

Hardware version: V1.0

Software version.....: V1.0

Ratings.....: TX: DC 3.0V From battery

RX: DC 12.0V From external circuit

Result.....: **PASS**

Shenzhen CTA Testing Technology Co., Ltd.

Room 106, Building 1, Yibaolai Industrial Park, Qiaotou Community, Fuhai Street, Bao'an District, Shenzhen, China
 Tel:+86-755 2322 5875 E-mail:cta@cta-test.cn Web:http://www.cta-test.cn

TEST REPORT

Equipment under Test : UHF wireless microphone

Model /Type : WRL848+WRLM-18

Listed Models : WRL838TDV+WRLM-10, WRL858+WRLM-11,
WRL718+WRLM-12, WRL728+WRLM-13, WRL738+WRLM-14,
WRL868instr+WRLM-15, WRL750+WRLM-16,
REC850+LA-12 TROLLEY MIC, WRL838+WRLM-17

Applicant : **Η εταιρεία Κ. ΜΙΧΟΣ και ΣΙΑ Ο.Ε.**

Address : Chalandriou Str. 5, Ag. Paraskevi Athens 15343, Greece

Manufacturer : **Η εταιρεία Κ. ΜΙΧΟΣ και ΣΙΑ Ο.Ε.**

Address : Chalandriou Str. 5, Ag. Paraskevi Athens 15343, Greece

Test Result	PASS
--------------------	-------------

The test report merely corresponds to the test sample.
It is not permitted to copy extracts of these test result without the written permission of the test laboratory.

Contents

<u>1.</u>	<u>TEST STANDARDS</u>	<u>4</u>
<u>2.</u>	<u>SUMMARY</u>	<u>5</u>
2.1.	General Remarks	5
2.2.	Product Description	5
2.3.	EUT operation mode	5
2.4.	EUT configuration	6
2.5.	Modifications	6
<u>3.</u>	<u>TEST ENVIRONMENT</u>	<u>7</u>
3.1.	Address of the test laboratory	7
3.2.	Environmental conditions	7
3.3.	Test Description	7
3.4.	Statement of the measurement uncertainty	8
3.5.	Equipments Used during the Test	9
<u>4.</u>	<u>TEST CONDITIONS AND RESULTS</u>	<u>12</u>
4.1.	EMISSION	12
4.1.1.	Radiated Emission.....	12
4.1.2.	Conducted Emission.....	17
4.1.3.	Harmonic Current Emission.....	20
4.1.4.	Voltage Fluctuation and Flicker	21
4.2.	IMMUNITY	22
4.2.1.	Performance criteria	22
4.2.2.	Monitoring EUT in Immunity Test	23
4.2.3.	Electrostatic Discharge	24
4.2.4.	RF Electromagnetic Field	26
4.2.5.	Surges	27
4.2.6.	RF- Common Mode 0.15MHz to 80MHz	28
4.2.7.	Fast Transients Common Mode	29
4.2.8.	Voltage Dips and Interruptions	30
<u>5.</u>	<u>TEST SET-UP PHOTOS OF THE EUT</u>	<u>31</u>
<u>6.</u>	<u>EXTERNAL AND INTERNAL PHOTOS OF THE EUT</u>	<u>34</u>

1. TEST STANDARDS

The tests were performed according to following standards:

[ETSI EN 301 489-1 V2.2.3 \(2019-11\)](#)—ElectroMagnetic Compatibility (EMC) standard for radio equipment and services; Part 1: Common technical requirements; Harmonised Standard for ElectroMagnetic Compatibility

[ETSI EN 301 489-9 V2.1.1 \(2019-04\)](#)—ElectroMagnetic Compatibility (EMC) standard for radio equipment and services; Part 9: Specific conditions for WIRELESS MICROPHONES, similar Radio Frequency (RF) audio link equipment, cordless audio and in-ear monitoring devices; Harmonised Standard covering the essential requirements of article 3.1(b) of Directive 2014/53/EU

[EN 55032:2015+A11:2020](#)- Electromagnetic compatibility of multimedia equipment - Emission Requirements

[EN 55035:2017+A11:2020](#)- Electromagnetic compatibility of multimedia equipment - Immunity requirements

[EN IEC 61000-3-2:2019/A2:2024](#)-Electromagnetic compatibility (EMC) - Part 3-2: Limits - Limits for harmonic current emissions (equipment input current ≤ 16 A per phase)

[EN 61000-3-3:2013/A2:2021/AC:2022](#)- Electromagnetic compatibility (EMC) - Part 3-3: Limits - Limitation of voltage changes, voltage fluctuations and flicker in public low-voltage supply systems, for equipment with rated current ≤ 16 A per phase and not subject to conditional connection

2. SUMMARY

2.1. General Remarks

Date of receipt of test sample	:	Aug. 24, 2024
Testing commenced on	:	Aug. 24, 2024
Testing concluded on	:	Aug. 30, 2024

2.2. Product Description

Product Name:	UHF wireless microphone
Model/Type reference:	WRL848+WRLM-18
Power supply:	TX: DC 3.0V From battery RX: DC 12.0V From external circuit
Adapter information:	Model: TY-801A Input: AC 100-240V 50/60Hz 0.25A Output: DC 12V 1A
Wireless microphone	
Operation frequency:	660.3-690.0MHz
Modulation Type:	FM
Hardware Version:	V1.0
Software Version:	V1.0
Antenna	TX: Internal antenna, 0.8dBi (Max) RX: External antenna, 2.0dBi (Max)

2.3. EUT operation mode

There was 3 test Modes. TM1 to TM3 were shown below:

TM1: Operate in Wireless Microphone TX mode;

TM2: Operate in Wireless Microphone RX mode;

TM3: Idle mode.

Note:

1. Pre-scan above all test mode, found below test mode which it was worse case mode.

Test item	Test mode (Worse case mode)
Radiated emission	Mode 1
Conducted Emission(AC Mains)	Mode 1
EMS	Others: All Modes

2.4. EUT configuration

The following peripheral devices and interface cables were connected during the measurement:

- - supplied by the manufacturer
- - supplied by the lab

Manufacturer	Description	Model	Serial Number	Certificate
/	Mobile Speakers	A8-2	---	CE
Shenzhen Yuanxin technology Trade Co.,Ltd	adapter	TY-801A	---	CE

Note: Use the USB cable length less than 3 meter.

2.5. Modifications

No modifications were implemented to meet testing criteria.

3. TEST ENVIRONMENT

3.1. Address of the test laboratory

The test facility is recognized, certified, or accredited by the following organizations:

FCC-Registration No.: 517856 Designation Number: CN1318

Shenzhen CTA Testing Technology Co., Ltd. has been listed on the US Federal Communications Commission list of test facilities recognized to perform electromagnetic emissions measurements.

A2LA-Lab Cert. No.: 6534.01

Shenzhen CTA Testing Technology Co., Ltd. has been listed by American Association for Laboratory Accreditation to perform electromagnetic emission measurement.

The 3m-Semi anechoic test site fulfils CISPR 16-1-4 according to ANSI C63.10 and CISPR 16-1-4:2010

3.2. Environmental conditions

During the measurement the environmental conditions were within the listed ranges:

Normal Temperature:	25°C
Relative Humidity	55 %
Air Pressure	989 hPa

3.3. Test Description

Emission Measurement		
Radiated Emission	ETSI EN 301 489-1 V2.2.3 (2019-11) ETSI EN 301 489-9 V2.1.1 (2019-04) EN 55032:2015+A11:2020	PASS
Conducted Emission(AC Mains)	ETSI EN 301 489-1 V2.2.3 (2019-11) ETSI EN 301 489-9 V2.1.1 (2019-04) EN 55032:2015+A11:2020	PASS
Harmonic Current Emissions	ETSI EN 301 489-1 V2.2.3 (2019-11) ETSI EN 301 489-9 V2.1.1 (2019-04) EN IEC 61000-3-2:2019/A2:2024	N/A
Voltage Fluctuations and Flicker	ETSI EN 301 489-1 V2.2.3 (2019-11) ETSI EN 301 489-9 V2.1.1 (2019-04) EN 61000-3-3:2013/A2:2021/AC:2022	N/A
Immunity Measurement		
Electrostatic Discharge	ETSI EN 301 489-1 V2.2.3 (2019-11) ETSI EN 301 489-9 V2.1.1 (2019-04) EN 55035:2017+A11:2020	PASS
RF Electromagnetic Field	ETSI EN 301 489-1 V2.2.3 (2019-11) ETSI EN 301 489-9 V2.1.1 (2019-04) EN 55035:2017+A11:2020	PASS
Fast Transients Common Mode	ETSI EN 301 489-1 V2.2.3 (2019-11) ETSI EN 301 489-9 V2.1.1 (2019-04) EN 55035:2017+A11:2020	PASS
RF Common Mode 0,15 MHz to 80 MHz	ETSI EN 301 489-1 V2.2.3 (2019-11) ETSI EN 301 489-9 V2.1.1 (2019-04) EN 55035:2017+A11:2020	PASS
Voltage Dips and Interruptions	ETSI EN 301 489-1 V2.2.3 (2019-11) ETSI EN 301 489-9 V2.1.1 (2019-04) EN 55035:2017+A11:2020	PASS

Shenzhen CTA Testing Technology Co., Ltd.

Room 106, Building 1, Yibaolai Industrial Park, Qiaotou Community, Fuhai Street, Bao'an District, Shenzhen, China
Tel:+86-755 2322 5875 E-mail:cta@cta-test.cn Web:http://www.cta-test.cn

Surges	ETSI EN 301 489-1 V2.2.3 (2019-11) ETSI EN 301 489-9 V2.1.1 (2019-04) EN 55035:2017+A11:2020	PASS
--------	--	------

Remark:1. N/A means “not applicable”.

2.The measurement uncertainty is not included in the test result.

3.4. Statement of the measurement uncertainty

The data and results referenced in this document are true and accurate. The reader is cautioned that there may be errors within the calibration limits of the equipment and facilities. The measurement uncertainty was calculated for all measurements listed in this test report acc. to TR-100028-01” Electromagnetic compatibility and Radio spectrum Matters (ERM);Uncertainties in the measurement of mobile radio equipment characteristics; Part 1” and TR-100028-02 “Electromagnetic compatibility and Radio spectrum Matters (ERM);Uncertainties in the measurement of mobile radio equipment characteristics; Part 2 “ and is documented in the Shenzhen CTA Testing Technology Co., Ltd. quality system acc. to DIN EN ISO/IEC 17025. Furthermore, component and process variability of devices similar to that tested may result in additional deviation. The manufacturer has the sole responsibility of continued compliance of the device.

Hereafter the best measurement capability for Shenzhen CTA Testing Technology Co., Ltd. :

Test	Range	Measurement Uncertainty	Notes
Radiated Emission	9KHz~30MHz	3.02 dB	(1)
Radiated Emission	30~1000MHz	4.06 dB	(1)
Radiated Emission	1~18GHz	5.14 dB	(1)
Radiated Emission	18-40GHz	5.38 dB	(1)
Conducted Disturbance	0.15~30MHz	2.14 dB	(1)
Output Peak power	30MHz~18GHz	0.55 dB	(1)
Power spectral density	/	0.57 dB	(1)
Spectrum bandwidth	/	1.1%	(1)
Radiated spurious emission (30MHz-1GHz)	30~1000MHz	4.10 dB	(1)
Radiated spurious emission (1GHz-18GHz)	1~18GHz	4.32 dB	(1)
Radiated spurious emission (18GHz-40GHz)	18-40GHz	5.54 dB	(1)

(1)This uncertainty represents an expanded uncertainty expressed at approximately the 95% confidence level using a coverage factor of k=2.

3.5. Equipments Used during the Test

Conducted Emission						
Item	Test Equipment	Manufacturer	Model No.	Equipment No.	Last Cal.	Cal.Due
1	EMI Test Receiver	R&S	ESPI	CTA-307	2024/08/03	2025/08/02
2	Artificial Mains	R&S	ENV-216	CTA-308	2024/08/03	2025/08/02
3	Artificial Mains	R&S	ENV-216	CTA-314	2024/08/03	2025/08/02
4	ISN	Schwarzbeck	NTFM8158	CTA-407	2024/08/03	2025/08/02
5	ISN	Schwarzbeck	CAT58158	CTA-408	2024/08/03	2025/08/02
6	ISN	Schwarzbeck	CAT38158	CTA-409	2024/08/03	2025/08/02
7	Universal Radio Communication	R&S	CMW500	CTA-302	2024/08/03	2025/08/02
8	EMI Test Software	Tonscend	TS@JS32-CE	N/A	N/A	N/A

Harmonic Current/ Voltage Fluctuation and Flicker						
Item	Test Equipment	Manufacturer	Model No.	Equipment No.	Last Cal.	Cal.Due
1	Harmonic and Flicker Analyzer	Voltech	PM6000	CTA-339	2024/08/03	2025/08/02
2	Universal Radio Communication	R&S	CMW500	CTA-302	2024/08/03	2025/08/02

Electrostatic Discharge						
Item	Test Equipment	Manufacturer	Model No.	Equipment No.	Last Cal.	Cal.Due
1	ESD Simulators	NOISEKEN	ESS-100L(A)	CTA-315	2024/08/03	2025/08/02
2	Universal Radio Communication	R&S	CMW500	CTA-302	2024/08/03	2025/08/02

Radiated Emission						
Item	Test Equipment	Manufacturer	Model No.	Equipment No.	Last Cal.	Cal.Due
1	Ultra-Broadband Antenna	Schwarzbeck	VULB9163	CTA-310	2023/10/17	2024/10/16
2	EMI Test Receiver	ROHDE & SCHWARZ	ESCI	CTA-306	2024/08/03	2025/08/02
3	Horn Antenna	Schwarzbeck	BBHA 9120D	CTA-309	2023/10/13	2024/10/12
4	Universal Radio Communication	CMW500	R&S	CTA-302	2024/08/03	2025/08/02
5	Band-reject filter	Xi'an Xingbo Technology Co.,Ltd	XBLBQ-DZA66	CTA-410	2024/08/03	2025/08/02

Shenzhen CTA Testing Technology Co., Ltd.

Room 106, Building 1, Yibaolai Industrial Park, Qiaotou Community, Fuhai Street, Bao'an District, Shenzhen, China
Tel:+86-755 2322 5875 E-mail:cta@cta-test.cn Web:http://www.cta-test.cn

6	Band-reject filter	Xi'an Xingbo Technology Co.,Ltd	XBLBQ-DZA64	CTA-411	2024/08/03	2025/08/02
7	Band-reject filter	Xi'an Xingbo Technology Co.,Ltd	XBLBQ-DZA63	CTA-411	2024/08/03	2025/08/02
8	High-pass filter	Xi'an Xingbo Technology Co.,Ltd	XBLBQ-GTA10	CTA-412	2024/08/03	2025/08/02
9	High-pass filter	Xi'an Xingbo Technology Co.,Ltd	XBLBQ-GTA18	CTA-402	2024/08/03	2025/08/02
10	EMI Test Software	Tonscend	TS@JS32-RE	N/A	N/A	N/A

Electrical Fast Transient						
Item	Test Equipment	Manufacturer	Model No.	Equipment No.	Last Cal.	Cal.Due
1	Fast Transient Burst Simulator	Prima	EFT61004TA	CTA-316	2024/08/03	2025/08/02
2	Coupling Clamp	Prima	EFT-CLAMP	CTA-317	2024/08/03	2025/08/02
3	Universal Radio Communication	R&S	CMW500	CTA-302	2024/08/03	2025/08/02

Surge						
Item	Test Equipment	Manufacturer	Model No.	Equipment No.	Last Cal.	Cal.Due
1	Lightning Surge Generator	Prima	SUG61005TB	CTA-318	2024/08/03	2025/08/02
2	Lightning Surge Generator	Prima	SUG10/700TA	CTA-319	2024/08/03	2025/08/02
3	Universal Radio Communication	R&S	CMW500	CTA-302	2024/08/03	2025/08/02

Dips						
Item	Test Equipment	Manufacturer	Model No.	Equipment No.	Last Cal.	Cal.Due
1	Cycle Sag Simulator	Prima	DRP61011TA	CTA-321	2024/08/03	2025/08/02
2	Universal Radio Communication	R&S	CMW500	CTA-302	2024/08/03	2025/08/02

RF Field Strength Susceptibility						
Item	Test Equipment	Manufacturer	Model No.	Equipment No.	Last Cal.	Cal.Due
1	SIGNAL GENERATOR	Agilent	N5182A	CTA-305	2024/08/03	2025/08/02
2	POWER AMPLIFIER	AR	150W1000	CTA-413	2024/08/03	2025/08/02
3	POWER AMPLIFIER	Mictop	MPA-1000-6000-100	CTA-414	2024/08/03	2025/08/02
4	DUAL DIRECTIONAL COUPLER	AR	DC6080	CTA-415	2024/08/03	2025/08/02

Shenzhen CTA Testing Technology Co., Ltd.

Room 106, Building 1, Yibaolai Industrial Park, Qiaotou Community, Fuhai Street, Bao'an District, Shenzhen, China
Tel:+86-755 2322 5875 E-mail:cta@cta-test.cn Web:http://www.cta-test.cn

5	POWER METER	Agilent	E4419B	CTA-416	2024/08/03	2025/08/02
6	Power sensor	Agilent	E9301A	CTA-417	2024/08/03	2025/08/02
7	Power sensor	Agilent	8483A	CTA-418	2024/08/03	2025/08/02
8	TRANSMITTING ANTENNA	AR	AT1080	CTA-419	2023/10/17	2024/10/16
9	TRANSMITTING ANTENNA	Schwarzbeck	STLP 9149	CTA-420	2023/10/17	2024/10/16
10	Radio Communication Tester	R&S	CMW500	CTA-302	2024/08/03	2025/08/02
11	Audio Analyzer	R&S	UPL	CTA-421	2024/08/03	2025/08/02

Conducted Susceptibility						
Item	Test Equipment	Manufacturer	Model No.	Equipment No.	Last Cal.	Cal.Due
1	CS Test system	Schloder	CDG 6000-75	CTA-322	2024/08/03	2025/08/02
2	CDN M2+M3	Zhinan	ZN3750	CTA-323	2024/08/03	2025/08/02
3	6dB Attenuator	Schloder	CDG60100	CTA-324	2024/08/03	2025/08/02
4	EM Clamp	Schloder	EMCL-20	CTA-325	2024/08/03	2025/08/02
5	Audio Analyzer	R&S	UPL	CTA-421	2024/08/03	2025/08/02
6	Universal Radio Communication	R&S	CMW500	CTA-302	2024/08/03	2025/08/02

Test Equipment	Manufacturer	Model No.	Version number	Calibration Date	Calibration Due Date
EMI Test Software	Tonscend	TS@JS32-RE	5.0.0.2	N/A	N/A
EMI Test Software	Tonscend	TS@JS32-CE	5.0.0.1	N/A	N/A
RF Test Software	Tonscend	TS@JS1120-3	3.1.65	N/A	N/A
RF Test Software	Tonscend	TS@JS1120	3.1.46	N/A	N/A

4. TEST CONDITIONS AND RESULTS

4.1. EMISSION

4.1.1. Radiated Emission

LIMIT

Please refer to ETSI EN301489-1 Clause 8.2.3, Table 4 and EN55032 Annex A, Table A.2,A.3, and Class B

TEST CONFIGURATION

- a) Radiated emission test set-up, frequency below 1000MHz:

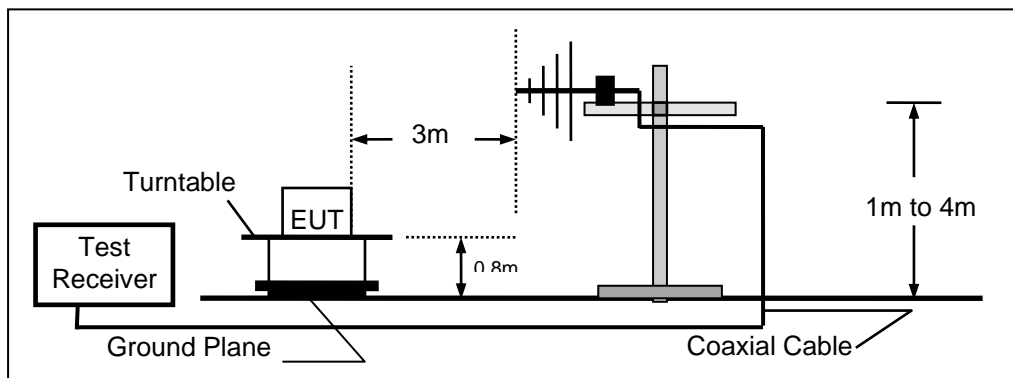

- b) Radiated emission test set-up, frequency above 1000MHz

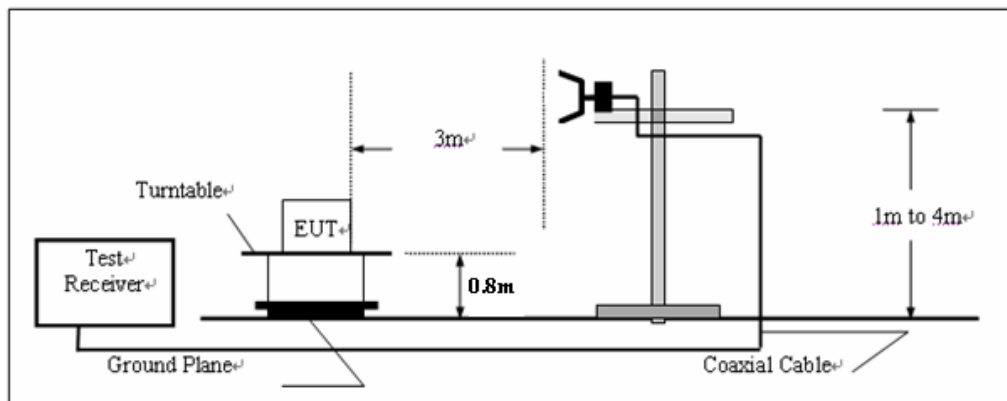

TEST PROCEDURE

Please refer to ETSI EN 301 489-1 Clause 8.2.3 and EN55032 Annex A for the measurement methods

TEST RESULTS

Passed

Please refer to the below test data:

Note 1: While performing the testing, the notch filter is used for avoiding test instrument overload.
Note 2: This test was performed with EUT in X, Y, Z position and the worst case was found when EUT in X position.

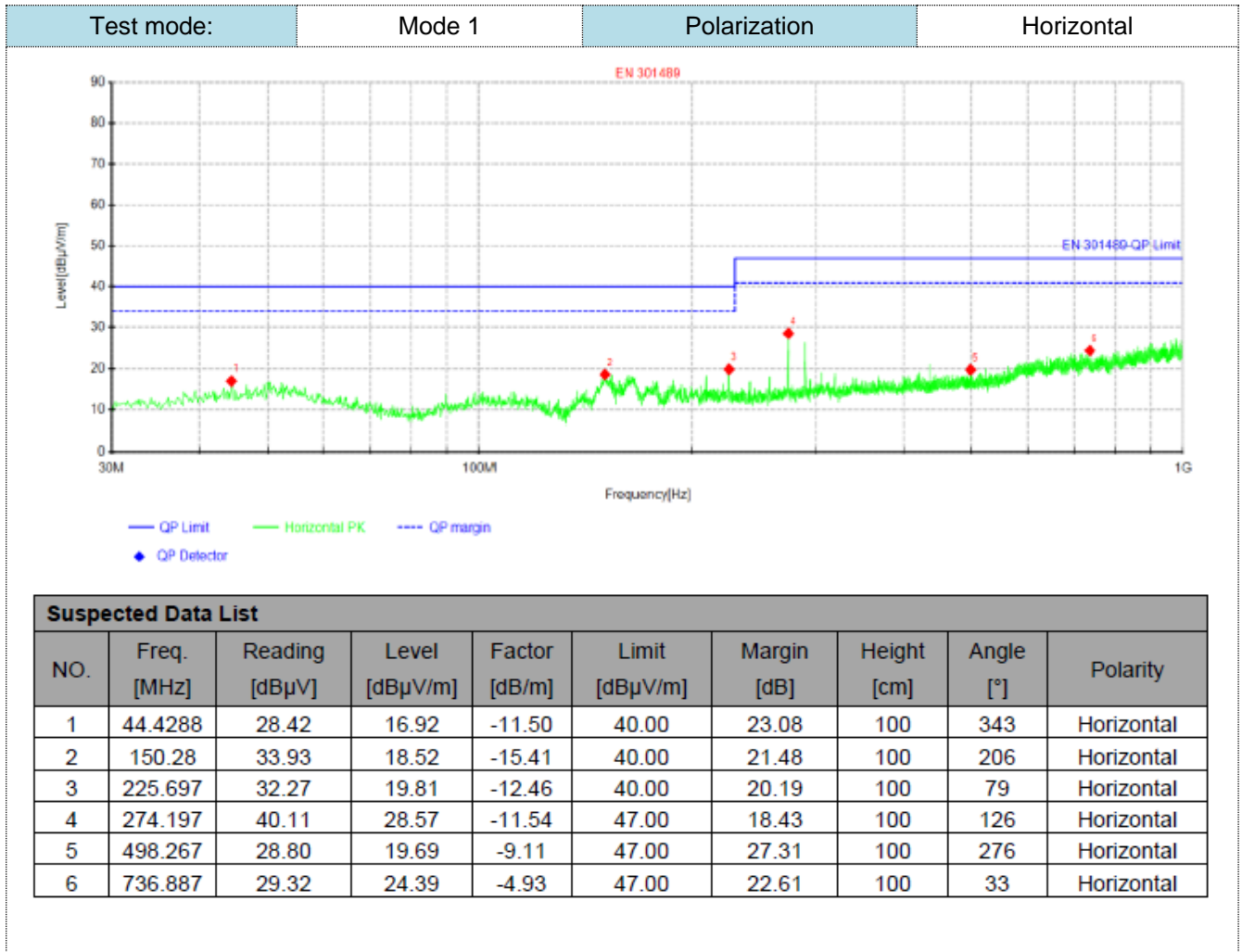

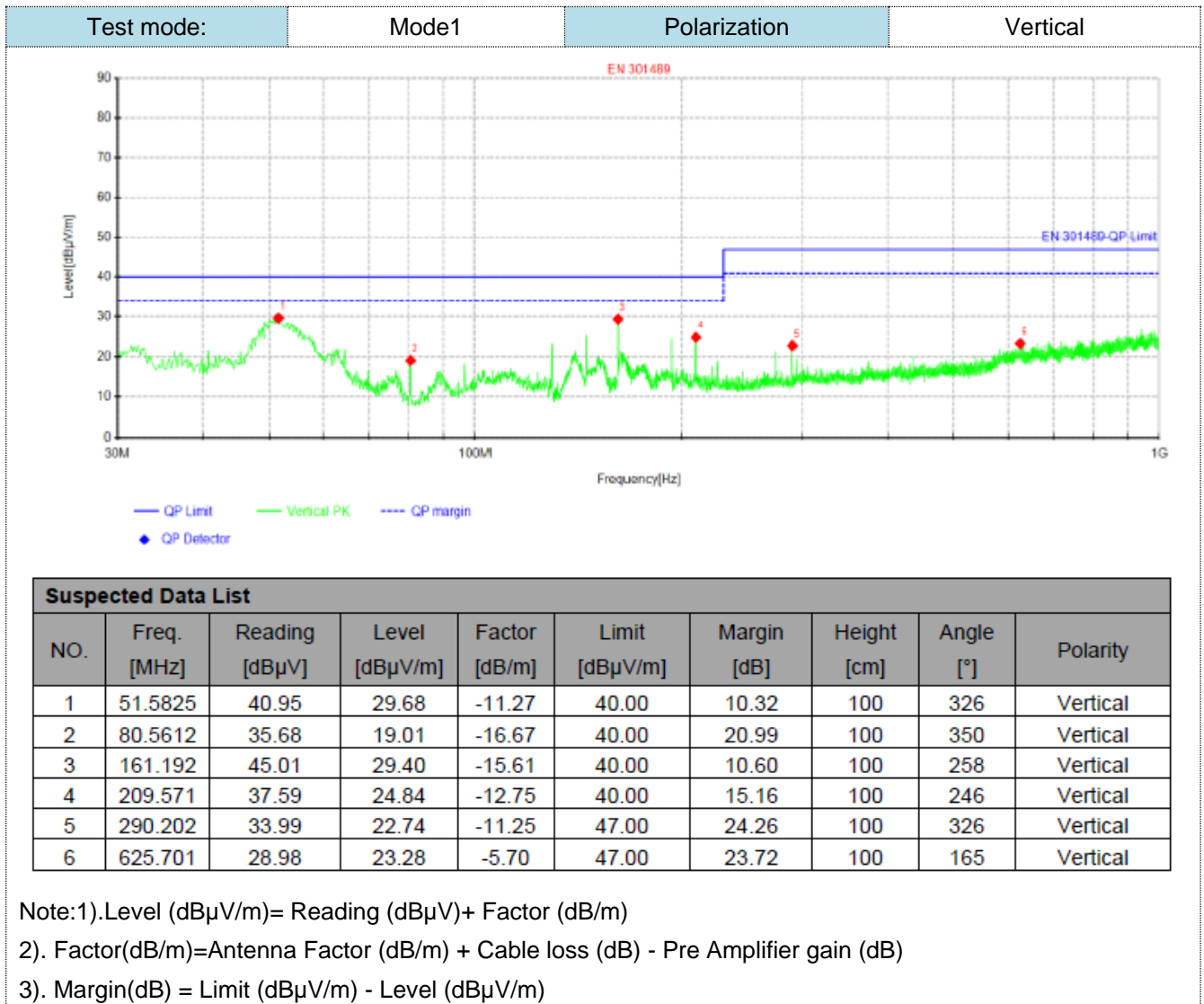

Test mode:	Mode 1	Polarization	Horizontal
------------	--------	--------------	------------

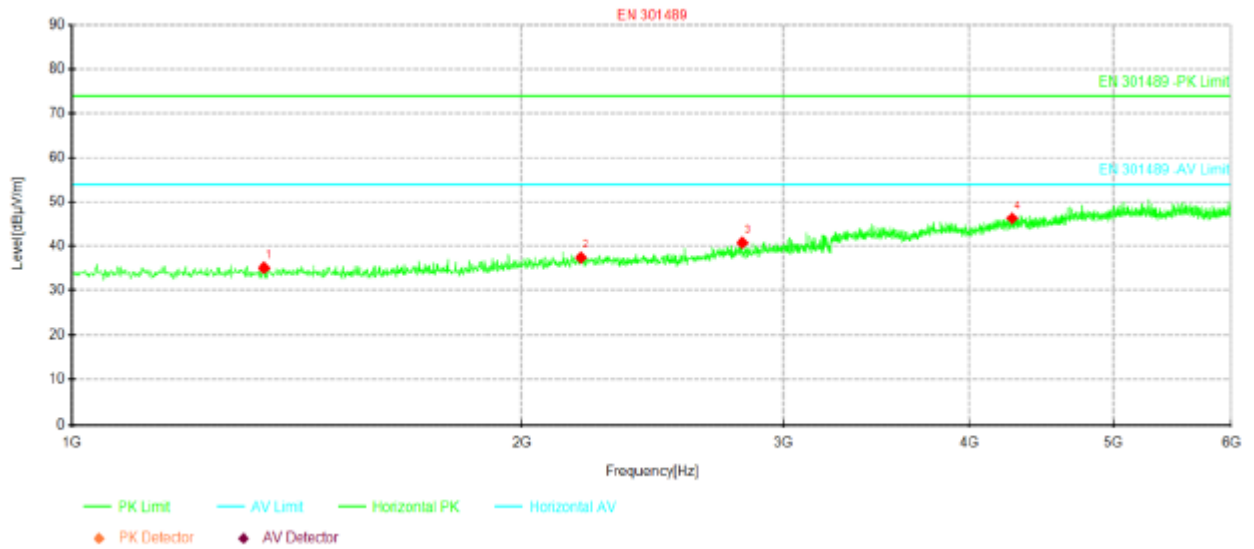

Suspected Data List

NO.	Freq. [MHz]	Reading [dBµV]	Level [dBµV/m]	Factor [dB/m]	Limit [dBµV/m]	Margin [dB]	Height [cm]	Angle [°]	Polarity
1	1346.25	99.83	35.11	-64.72	74.00	38.89	100	150	Horizontal
2	2192.5	99.97	37.42	-62.55	74.00	36.58	100	260	Horizontal
3	2815	101.82	40.77	-61.05	74.00	33.23	100	340	Horizontal
4	4273.75	104.15	46.34	-57.81	74.00	27.66	100	290	Horizontal

Test mode:

Mode 1

Polarization

Vertical

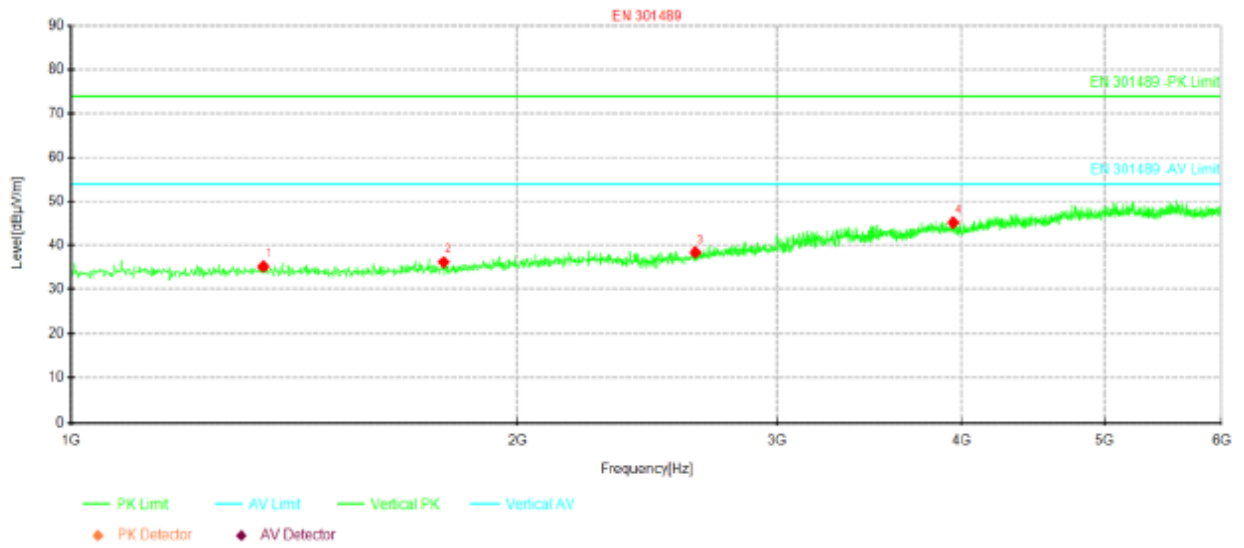

Suspected Data List

NO.	Freq. [MHz]	Reading [dBµV]	Level [dBµV/m]	Factor [dB/m]	Limit [dBµV/m]	Margin [dB]	Height [cm]	Angle [°]	Polarity
1	1350	99.92	35.20	-64.72	74.00	38.80	100	80	Vertical
2	1788.75	100.44	36.20	-64.24	74.00	37.80	100	100	Vertical
3	2640	100.00	38.43	-61.57	74.00	35.57	100	120	Vertical
4	3947.5	104.40	45.20	-59.20	74.00	28.80	100	280	Vertical

4.1.2. Conducted Emission

LIMIT

Please refer to ETSI EN301489-1 Clause 8.4.3, Table 8 and EN55032 Annex A, Table A.10, A.12

TEST CONFIGURATION

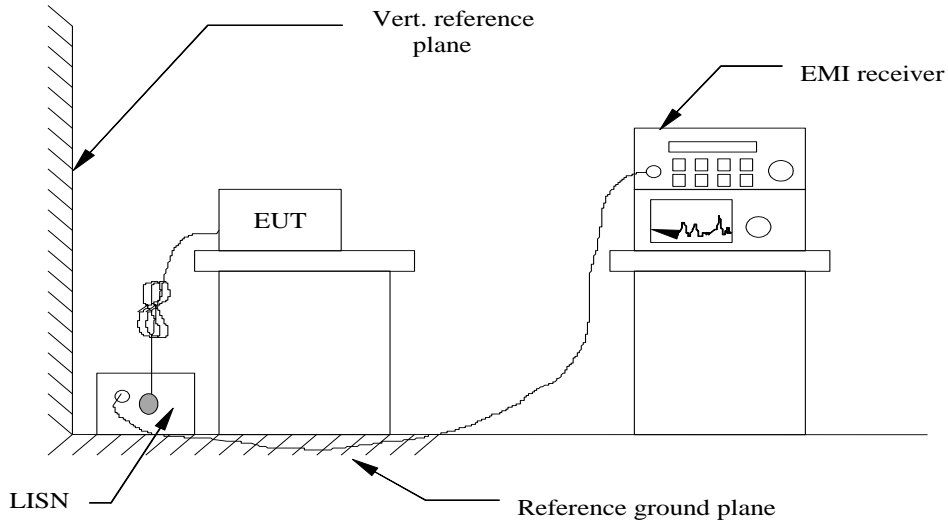

TEST PROCEDURE

Please refer to ETSI EN 301 489-1 Clause 8.4.3 and EN55032 Annex A for the measurement methods.

TEST RESULTS

Test mode:	Mode 1	Polarization	L
------------	--------	--------------	---

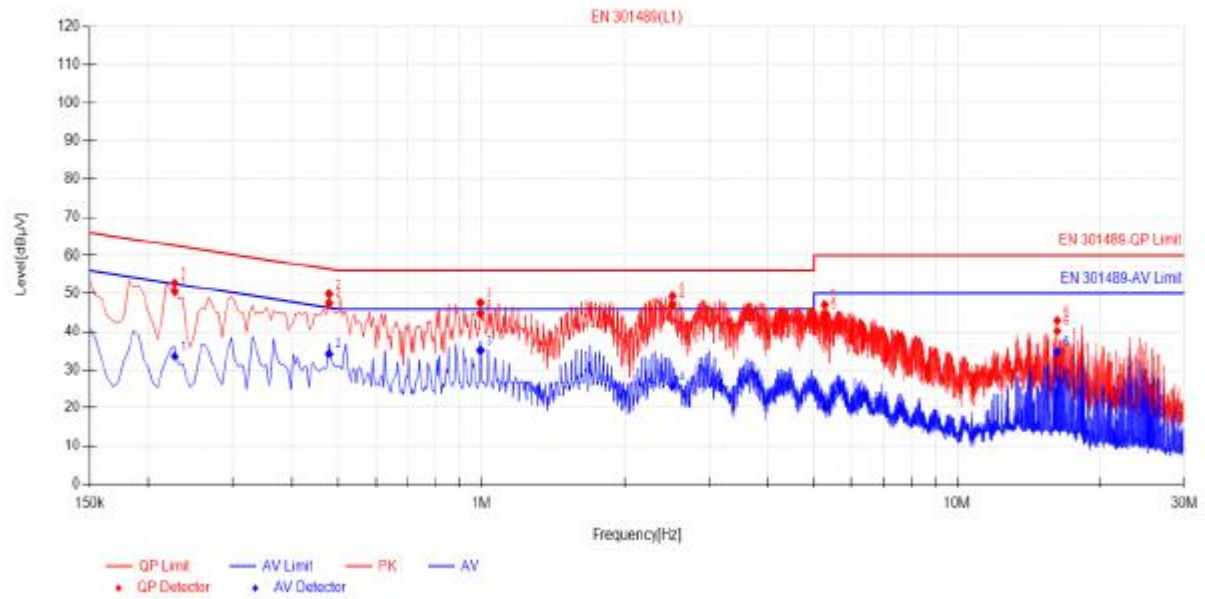

Final Data List											
NO.	Freq. [MHz]	Factor [dB]	QP Reading[dB µV]	QP Value [dBµV]	QP Limit [dBµV]	QP Margin [dB]	AV Reading [dBµV]	AV Value [dBµV]	AV Limit [dBµV]	AV Margin [dB]	Verdict
1	0.2285	10.01	40.48	50.49	62.58	12.09	23.53	33.54	52.58	19.04	PASS
2	0.4785	9.99	37.59	47.58	56.37	8.79	24.21	34.20	46.37	12.17	PASS
3	0.996	9.91	34.78	44.69	56.00	11.31	25.24	35.15	46.00	10.85	PASS
4	2.5215	10.10	37.02	47.12	56.00	8.88	15.55	25.65	46.00	20.35	PASS
5	5.2685	10.03	34.56	44.59	60.00	15.41	10.19	20.22	50.00	29.78	PASS
6	16.2285	10.33	29.89	40.22	60.00	19.78	24.38	34.71	50.00	15.29	PASS

Note:1).Level (dBµV/m)= Reading (dBµV/m)+ Factor (dB/m)

2). Factor(dB/m)=Cable loss (dB) + LISN Factor (dB)

Test mode:	Mode 1	Polarization	N
------------	--------	--------------	---

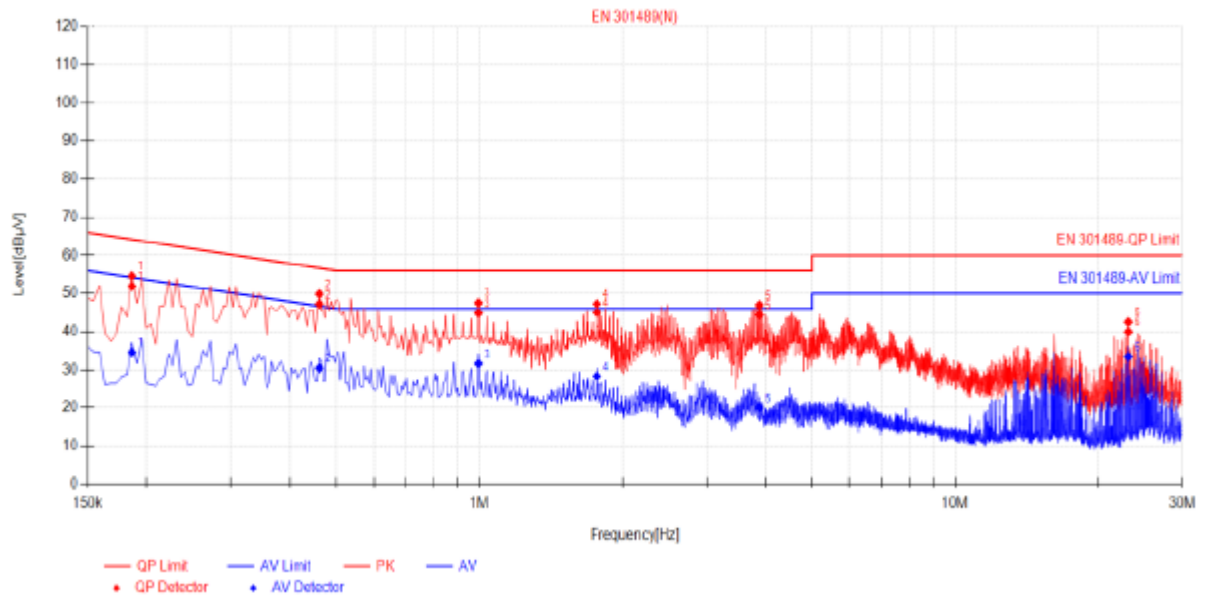

Final Data List

NO.	Freq. [MHz]	Factor [dB]	QP Reading [dBµV]	QP Value [dBµV]	QP Limit [dBµV]	QP Margin [dB]	AV Reading [dBµV]	AV Value [dBµV]	AV Limit [dBµV]	AV Margin [dB]	Verdict
1	0.186	10.01	41.92	51.93	64.21	12.28	24.55	34.56	54.21	19.65	PASS
2	0.4605	9.98	37.26	47.24	56.68	9.44	20.47	30.45	46.68	16.23	PASS
3	0.996	10.12	34.75	44.87	56.00	11.13	21.49	31.61	46.00	14.39	PASS
4	1.7655	10.16	34.86	45.02	56.00	10.98	18.19	28.35	46.00	17.65	PASS
5	3.876	10.13	34.28	44.41	56.00	11.59	9.89	20.02	46.00	25.98	PASS
6	23.127	10.65	29.33	39.98	60.00	20.02	22.80	33.45	50.00	16.55	PASS

Note:1). Level (dBµV/m)= Reading (dBµV/m)+ Factor (dB/m)

2). Factor(dB/m)=Cable loss (dB) + LISN Factor (dB)

4.1.3. Harmonic Current Emission

LIMIT

Please refer to EN 61000-3-2

TEST CONFIGURATION

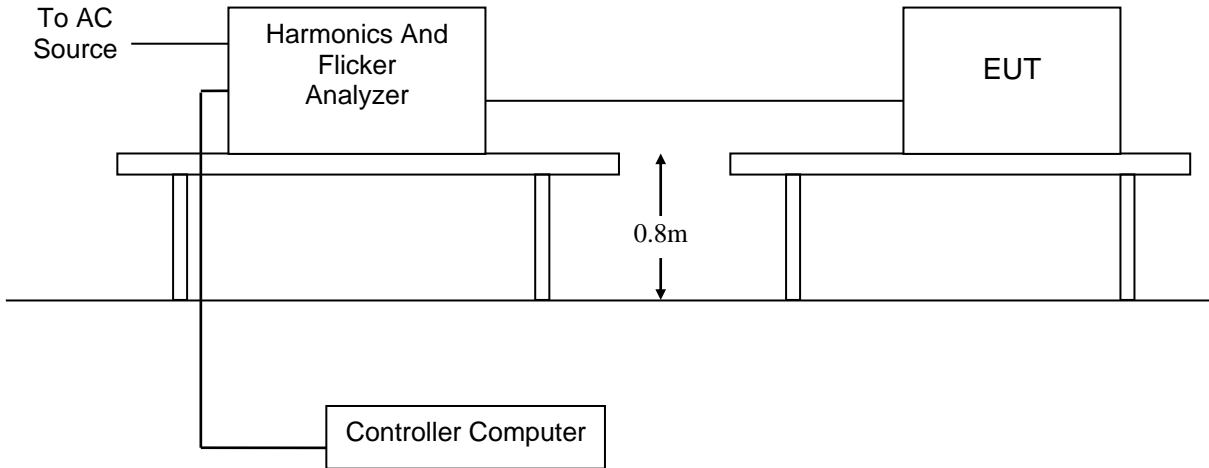

TEST PROCEDURE

Please refer to EN 61000-3-2 for the measurement methods.

TEST RESULTS

The power of this product is less than 75W, So this test item is not applicable for the EUT.

4.1.4. Voltage Fluctuation and Flicker

LIMIT

Please refer to EN 61000-3-3

TEST CONFIGURATION

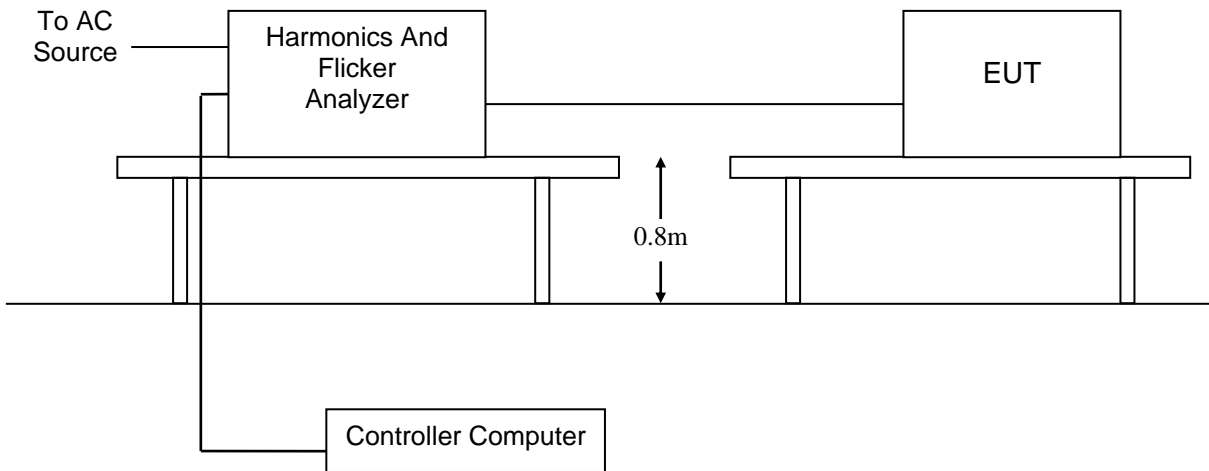

TEST PROCEDURE

Please refer to EN 61000-3-3 for the measurement methods.

TEST RESULTS

The maximum input power of the EUT is less than 20W, which unlikely to produce significant voltage fluctuation. Therefore this test item is not applicable for the EUT.

*See clause 6.1*** *** EN 61000-3-3:2013, clause 6.1:” ... Tests need not be made on equipment which is unlikely to produce significant voltage fluctuations or flicker. ...”.*

4.2. IMMUNITY

4.2.1. Performance criteria

■ Performance criteria for ETSI EN 301 489-9 V2.1.1 (2019-04)

During test	After test	Criteria
Operate as intended; Degradation of performance (see note 1); No loss of function.	Operate as intended; No degradation of performance (see note 2); No loss of function.	A
Loss of function (one or more).	Operate as intended; No degradation of performance (see note 2); Functions self-recoverable.	B
Loss of function (one or more).	Operate as intended; No degradation of performance (see note 2); Functions recoverable by the operator.	C
<p>NOTE 1: Degradation of performance during the test is understood as a degradation to a level not below a minimum performance level specified by the manufacturer for the use of the apparatus as intended. In some cases the specified minimum performance level may be replaced by a permissible degradation of performance. If the permissible degradation of performance is not specified by the manufacturer, then this may be derived from the product description and documentation (including leaflets and advertising) and what the user may reasonably expect from the apparatus if used as intended.</p> <p>NOTE 2: No degradation of performance after the test is understood as no degradation below a minimum performance level specified by the manufacturer for the use of the apparatus as intended. In some cases the specified minimum performance level may be replaced by a permissible degradation of performance. After the test no change of actual operating data or user retrievable data is allowed. If the minimum performance level or the permissible degradation of performance is not specified by the manufacturer, then either of these may be derived from the product description and documentation (including leaflets and advertising) and what the user may reasonably expect from the apparatus if used as intended.</p>		

■ Performance Criterion of EN55035

Criterion A: The equipment shall continue to operate as intended without operator intervention. No degradation of performance or loss of function is allowed below a performance level specified by the manufacturer when the equipment is used as intended.

Criterion B: After the test, the equipment shall continue to operate as intended without operator intervention. No degradation of performance or loss of function is allowed, after the application of the phenomena below a performance level specified by the manufacturer, when the equipment is used as intended.

Criterion C: Loss of function is allowed, provided the function is self-recoverable, or can be restored by the operation of the controls by the user in accordance with the manufacturer's instructions.

4.2.2. Monitoring EUT in Immunity Test

4.2.2.1 Monitoring for Continuous Phenomena Applied to the EUT

■ Microphone TX Mode

During the test, observe whether the EUT operate as intended, no loss of function and no unintentional transmissions. Monitoring PER and shall exceed 10%

After the test, Check the function and critical stored date of the EUT with no degradation.

In addition, when EUT working in Idle /Receiver mode, monitor whether the transmitter unintentionally operates.

4.2.2.2 Monitoring for Transient Phenomena Applied to the EUT

■ Microphone TX Mode

After the test, Check the function and critical stored date of the EUT with no degradation.

In addition, when EUT working in Idle /Receiver mode, monitor whether the transmitter unintentionally operates.

4.2.3. Electrostatic Discharge

LIMIT

SEVERITY LEVELS OF ELECTROSTATIC DISCHARGE

Test level: Contact Discharge at $\pm 2\text{KV}$, $\pm 4\text{KV}$ Air Discharge at $\pm 2\text{KV}$, $\pm 4\text{KV}$, $\pm 8\text{KV}$

TEST CONFIGURATION

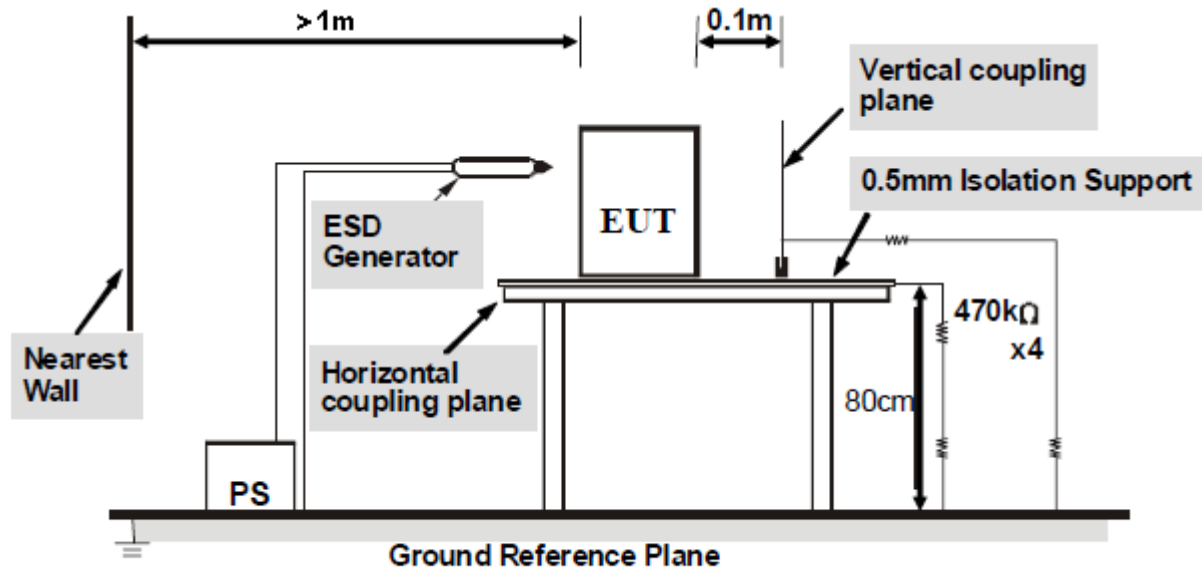

TEST PROCEDURE

Please refer to ETSI EN 301 489-1 Clause 9.3.2 , EN 55035 and EN 61000-4-2 for the measurement methods.

Contact Discharge:

The ESD generator is held perpendicular to the surface to which the discharge is applied and the tip of the discharge electrode touch the surface of EUT. Then turn the discharge switch. The generator is then re-triggered for a new single discharge and repeated at least 10 times for each pre-selected test point. This procedure shall be repeated until all the air discharge completed.

Air Discharge:

Air discharge is used where contact discharge can't be applied. The round discharge tip of the discharge electrode shall be approached as fast as possible to touch the EUT. After each discharge, the discharge electrode shall be removed from the EUT. The generator is then re-triggered for a new single discharge and repeated at least 10 times for each pre-selected test point. This procedure shall be repeated until all the air discharge completed.

Indirect discharge for horizontal coupling plane:

At least 10 single discharges shall be applied to the horizontal coupling plane, at points on each side of the EUT.

Indirect discharge for vertical coupling plane:

At least 10 single discharges shall be applied to the center of one vertical edge of the coupling plane. The coupling plane, of dimensions 0.5m X 0.5m, is placed parallel to, and positioned at a distance of 0.1m from the EUT. Discharges shall be applied to the coupling plane, with this plane in sufficient different positions that the four faces of the EUT are completely illuminated.

Please reference to the section 2.3

TEST RESULTS

Direct discharge				
Type of discharge	Discharge voltage (KV)	Observations Performance	Criteria Level	Result
Contact discharge	±2	No degradation in performance of the EUT was observed (A)	B	Pass
	±4		A	
Air discharge	±2	A	B	
	±4	A	B	
	±8	A	B	
Indirect discharge				
Type of discharge	Discharge voltage (KV)	Observations Performance	Criteria Level	Result
HCP (6 sides)	±2	A	B	Pass
	±4	A	B	
VCP (4 sides)	±2	A	B	
	±4	A	B	

Remark: The ancillary equipment's specification for an acceptable level of performance or degradation of performance during and/or after the ESD tests.

4.2.4. RF Electromagnetic Field

PERFORMANCE CRITERION

Criteria A

TEST LEVEL

3V/m (80%, 1kHz Amplitude Modulation)

TEST CONFIGURATION

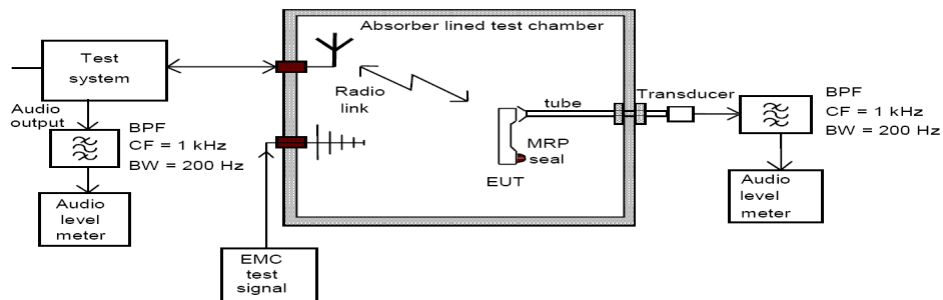

TEST PROCEDURE

Please refer to ETSI EN 301 489-1 Clause 9.2.2 and EN 61000-4-3 for the measurement methods.

TEST MODE

Please reference to the section 2.3

TEST RESULTS

- Idle mode

Test monitor: BCCH and CCCH

Frequency	Level	Modulation	Antenna Polarization	EUT Face	Observations (Performance Criterion)	Result
80MHz-6GHz	3 V/m	1 kHz, 80 % Amp. Mod, 1 % increment, dwell time=3seconds	V	Front	A	Pass
			H		A	Pass
			V	Rear	A	Pass
			H		A	Pass
			V	Left	A	Pass
			H		A	Pass
			V	Right	A	Pass
			H		A	Pass
			V	Top	A	Pass
			H		A	Pass
			V	Bottom	A	Pass
			H		A	Pass

Remark: A: During and after test, the EUT's(Microphone) PER less than 10%, there is no any degradation of performance.

4.2.5. Surges

PERFORMANCE CRITERION

Criteria B

TEST LEVEL

1kV Line to Line: Differential mode

2kV Line to Ground: Common mode

(Voltage Waveform: 1.2/50 us; Current Waveform: 8/20 us)

TEST CONFIGURATION

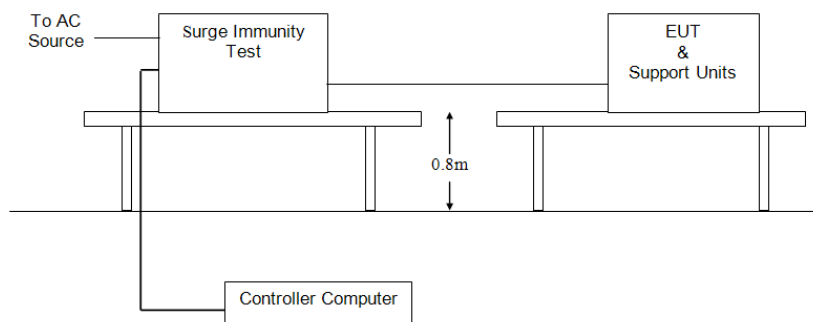

TEST PROCEDURE

Please refer to ETSI EN 301 489-1 Clause 9.8.2 and EN 61000-4-5 for the measurement methods.

TEST MODE

Please reference to the section 2.3

TEST RESULTS

Location	Level(kV)	Pulse No	Surge Interval	Phase(deg)	Observations (Performance Criterion)	Result
L-N	± 1	5	60s	0°	A	Pass
				90°	A	Pass
				180°	A	Pass
				270°	A	Pass

4.2.6. RF- Common Mode 0.15MHz to 80MHz

PERFORMANCE CRITERION

Criteria A

TEST LEVEL

3Vrms on AC main port (80%, 1kHz Amplitude Modulation)

TEST CONFIGURATION

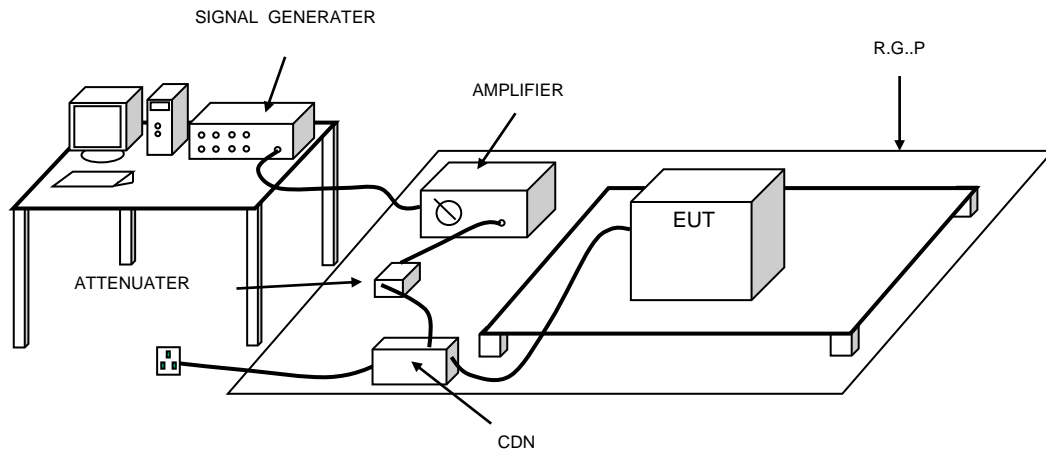

TEST PROCEDURE

Please refer to ETSI EN 301 489-1 Clause 9.5.2 and EN 61000-4-6 for the measurement methods.

TEST MODE

Please reference to the section 2.3

TEST RESULTS

Frequency	Injected Position	Level	Modulation	Observations (Performance Criterion)	Result
150kHz to 10MHz	AC Mains	3Vrms	1 kHz, 80 % Amp. Mod, 1 % increment, dwell time=3seconds	A	Pass
10MHz to 30MHz		3 Vrms to 1 Vrms			
30MHz to 80MHz		1 Vrms			

Remark: A: During and after test, the EUT's(Microphone) PER less than 10%, there is no any degradation of performance.

4.2.7. Fast Transients Common Mode

PERFORMANCE CRITERION

Criteria B

TEST LEVEL

1KV for AC main port

(Impulse Frequency: 5 kHz; Tr/Th: 5/50ns; Burst Duration: 15ms; Burst Period: 3Hz)

TEST CONFIGURATION

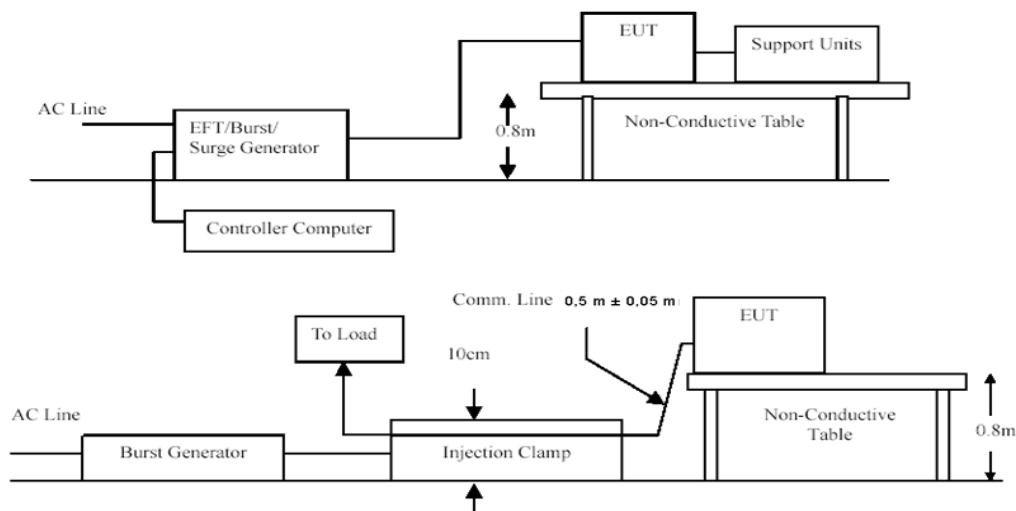

TEST PROCEDURE

Please refer to ETSI EN 301 489-1 Clause 9.4.2 , EN55035 and EN 61000-4-4 for the measurement methods.

TEST MODE

Please reference to the section 2.3

TEST RESULTS

Not applicable.

The device was powered by DC power.

Lead under Test	Level (±kV)	Coupling Direct/Clamp	Observations (Performance Criterion)	Result
L	±1	Direct	A	Pass
N	±1	Direct	A	Pass
L-N	±1	Direct	A	Pass

4.2.8. Voltage Dips and Interruptions

PERFORMANCE CRITERION

>95% VD, 0.5 period----Performance criterion: B

>95% VD, 1.0 period----Performance criterion: B

30% VD, 25 period----Performance criterion: C

>95% VI, 250 period----Performance criterion: C

TEST LEVEL

0% of VT(Supply Voltage) for 0.5 period

0% of VT(Supply Voltage) for 1.0 period

70% of VT(Supply Voltage) for 25 period

0% of VT(Supply Voltage) for 250 period

TEST CONFIGURATION

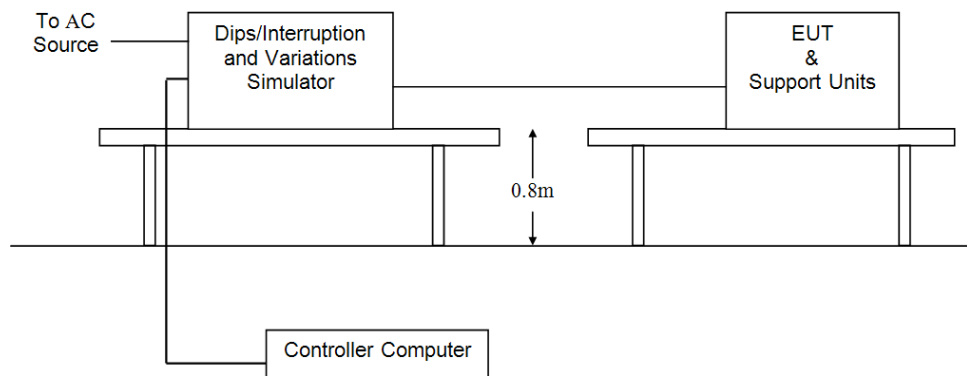

TEST PROCEDURE

Please refer to ETSI EN 301 489-1 Clause 9.7.2 and EN 61000-4-11 for the measurement methods.

TEST MODE

Please reference to the section 2.3

TEST RESULTS

Test Level % UT	Duration (Periods)	Phase angle	No. of drop out	Time between dropout	Observations (Performance Criterion)	Result
0	0.5	0°, 90°, 180°, 270°	3	10s	A	Pass
0	1.0	0°, 90°, 180°, 270°	3	10s	A	Pass
70	25	0°, 90°, 180°, 270°	3	10s	A	Pass
0	250	0°, 90°, 180°, 270°	3	10s	B	Pass

Remark :

A: No degradation in performance of the EUT was observed.

B: During the test, the power shut down, after the experiment, the function can automatically return to normal.

5. Test Set-up Photos of the EUT

Radiated Emission (30MHz-1GHz)



Radiated Emission (Above1GHz)



Conducted Emission



Shenzhen CTA Testing Technology Co., Ltd.

Room 106, Building 1, Yibaolai Industrial Park, Qiaotou Community, Fuhai Street, Bao'an District, Shenzhen, China
Tel:+86-755 2322 5875 E-mail:cta@cta-test.cn Web:http://www.cta-test.cn

Electrostatic Discharge



Surges



Voltage Dips and Interruptions



Fast Transients



RF Electromagnetic Field

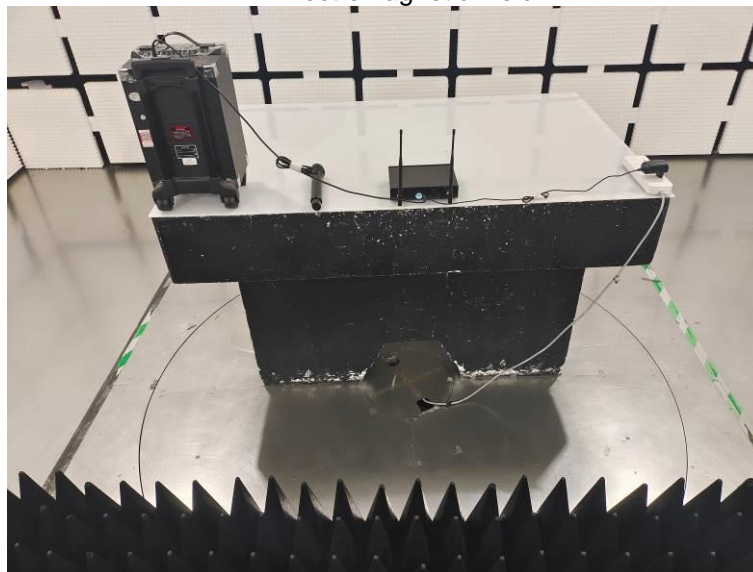

6. External and Internal Photos of the EUT



TX



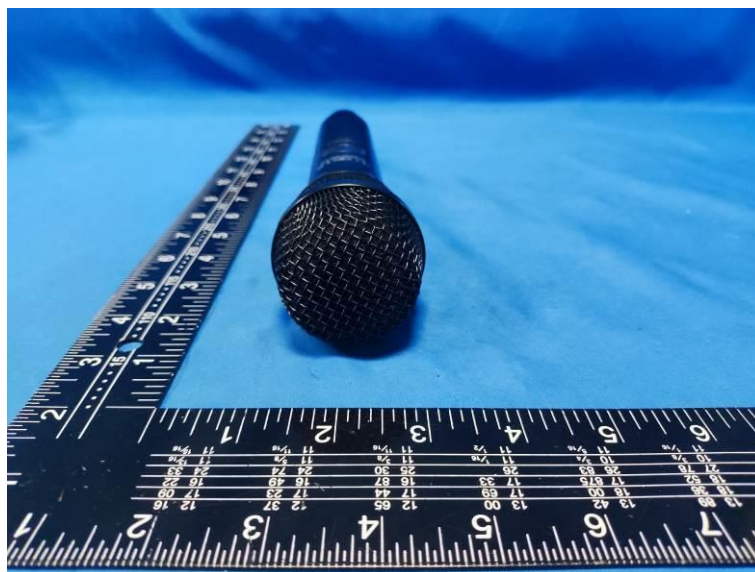

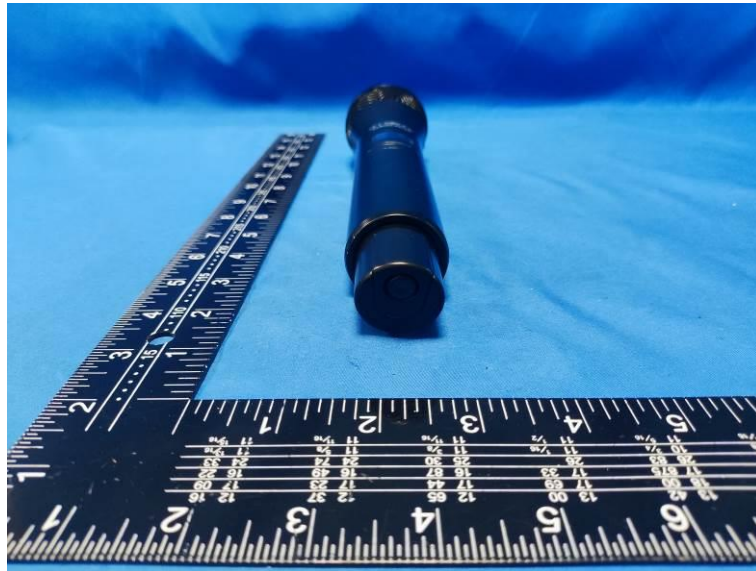

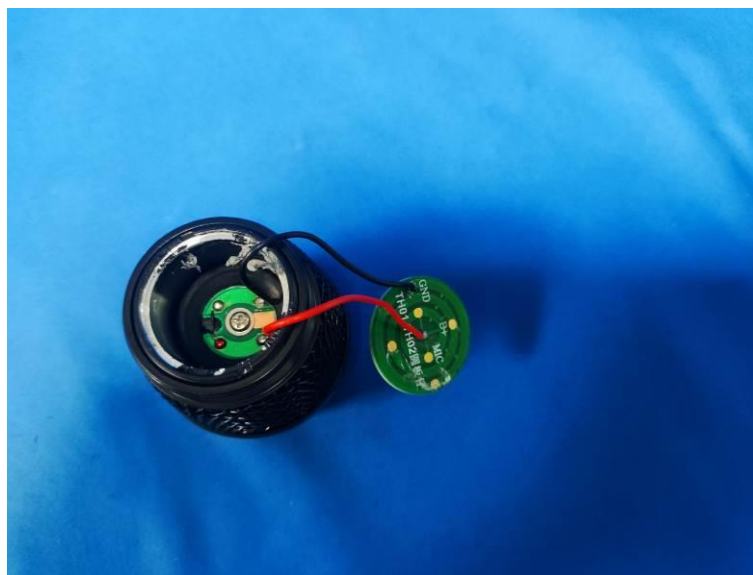

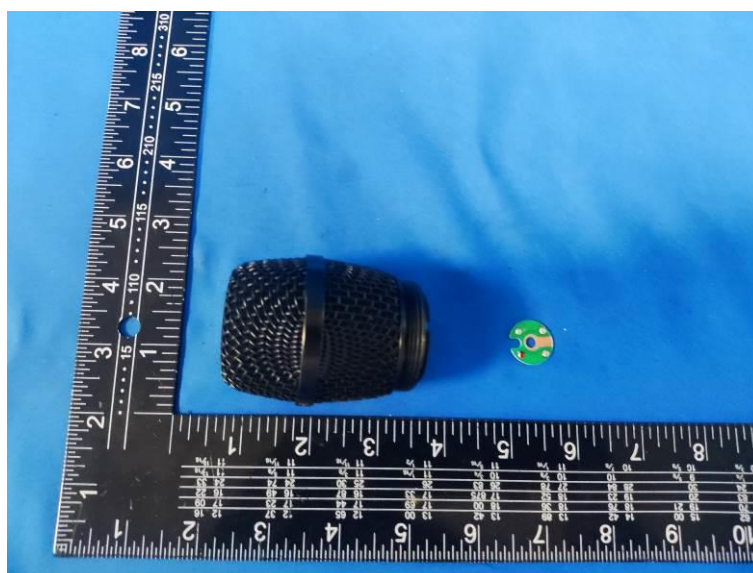
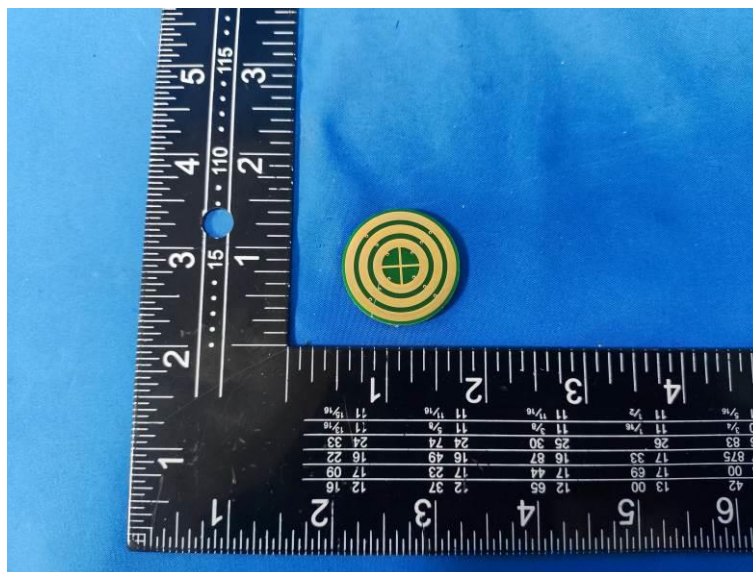
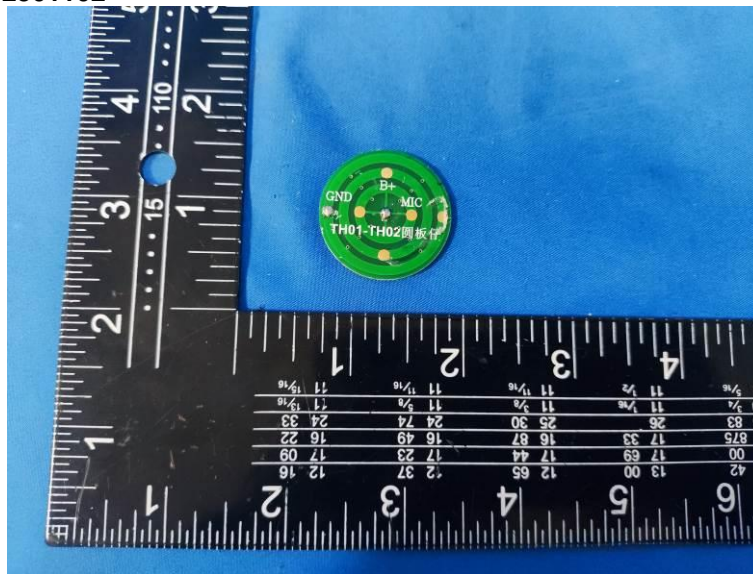

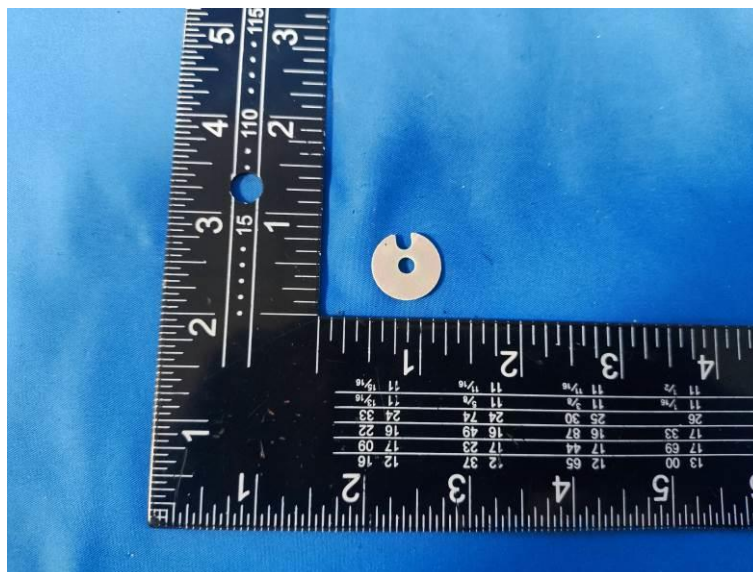
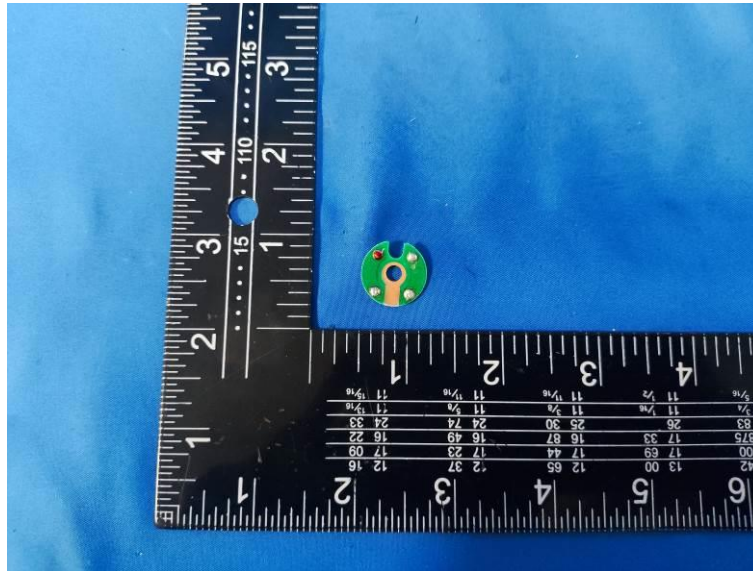

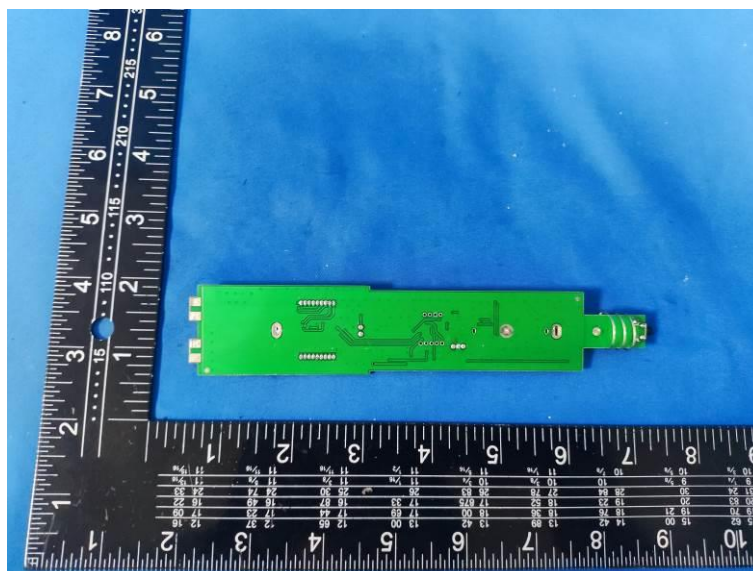
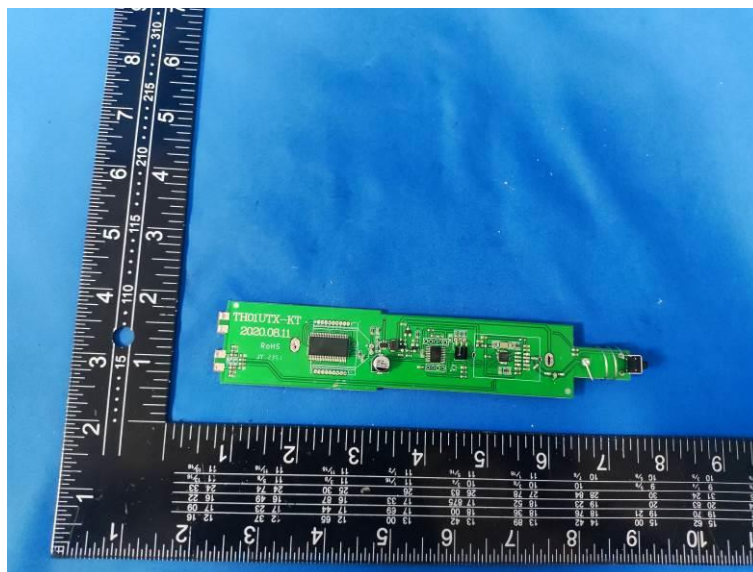

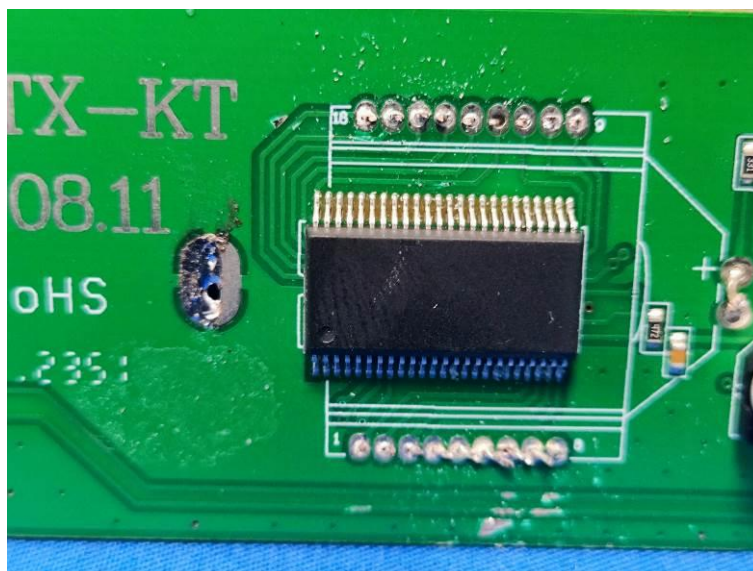
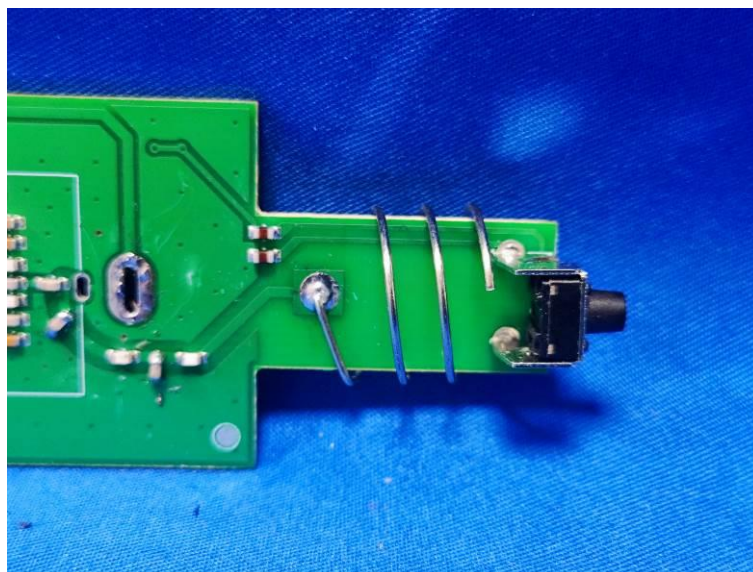
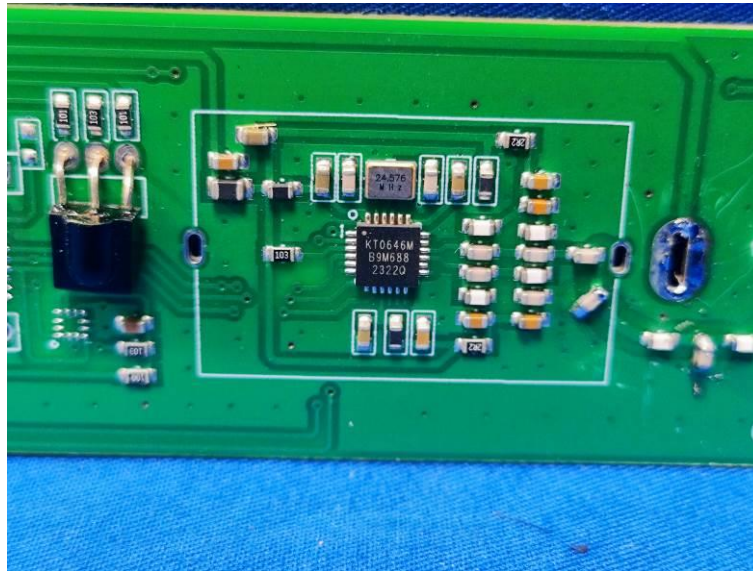

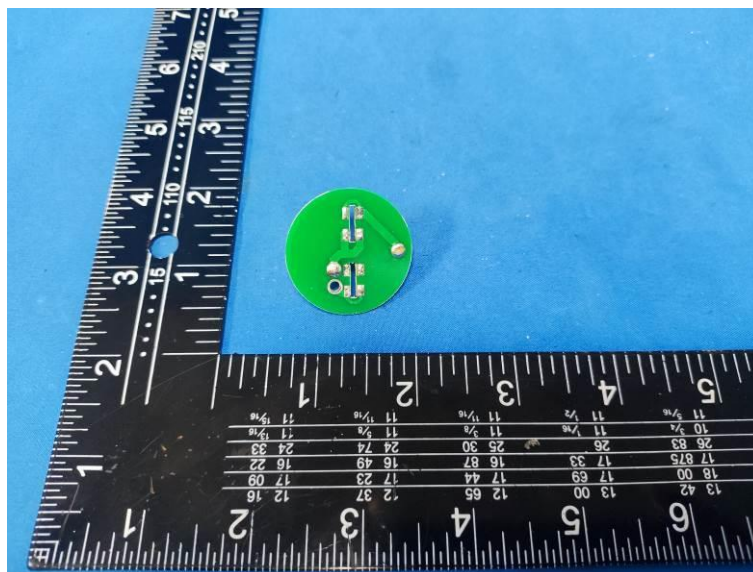
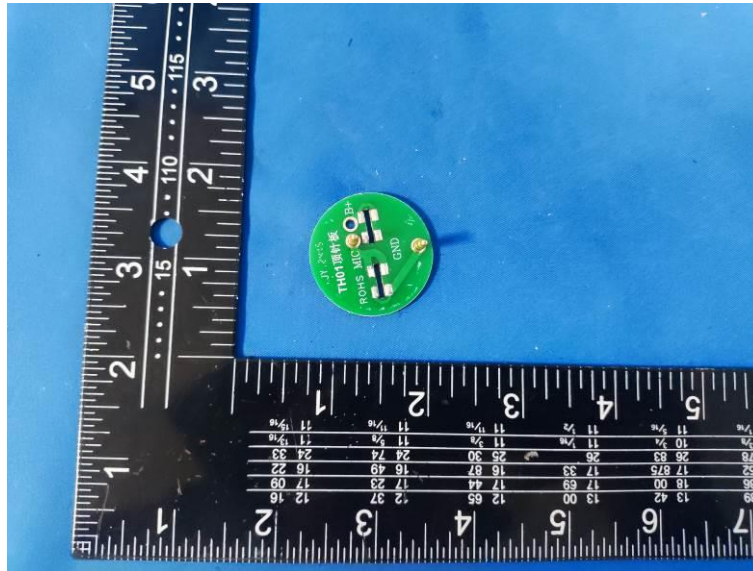

RX

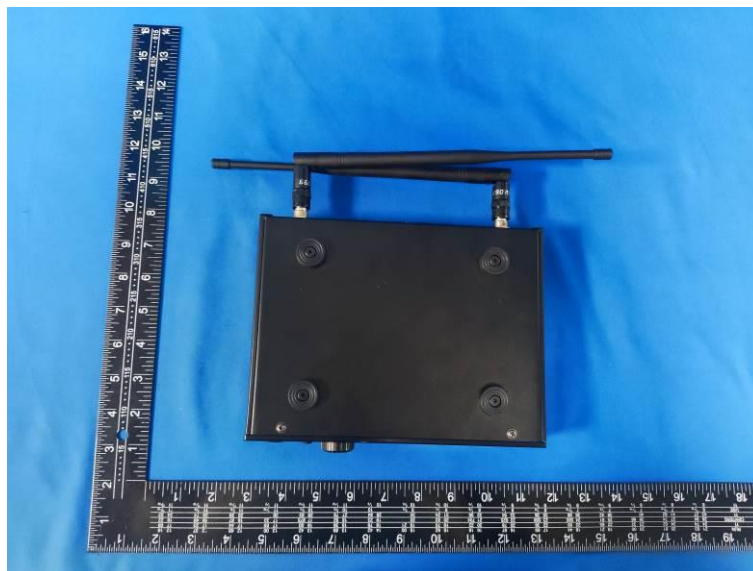

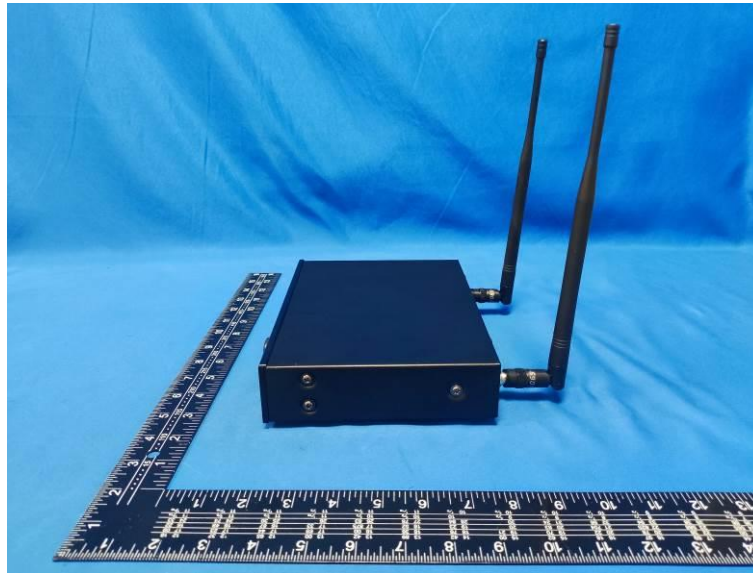

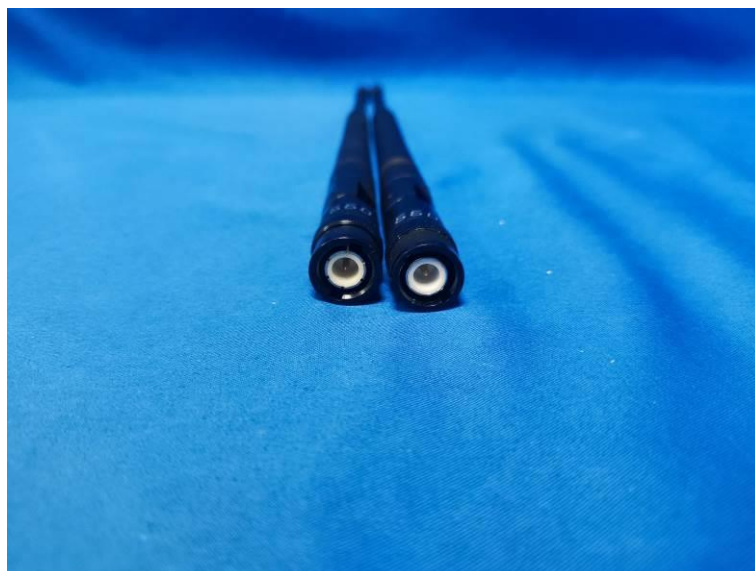
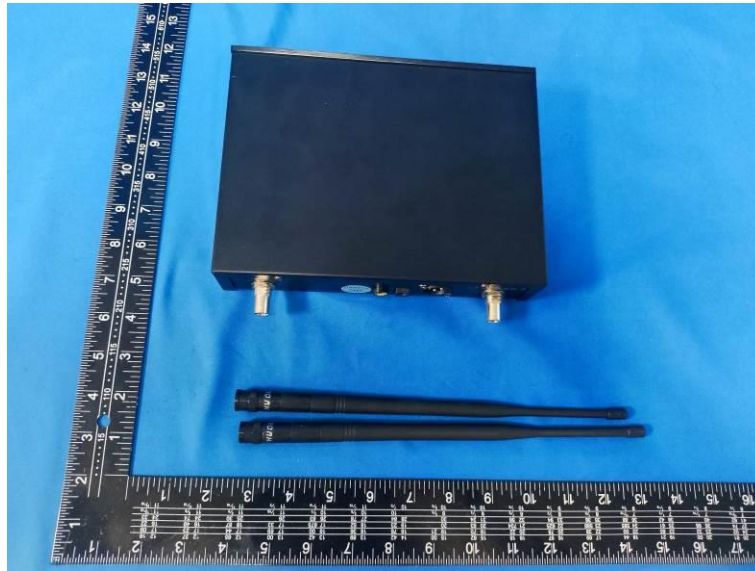

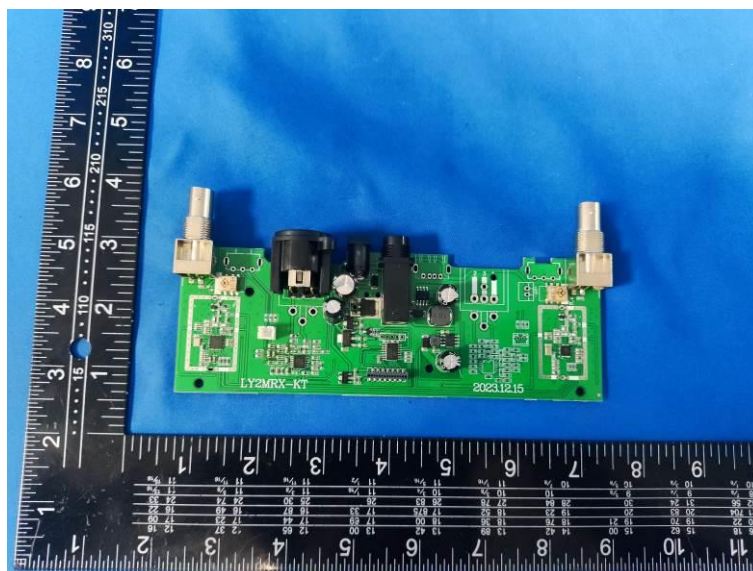
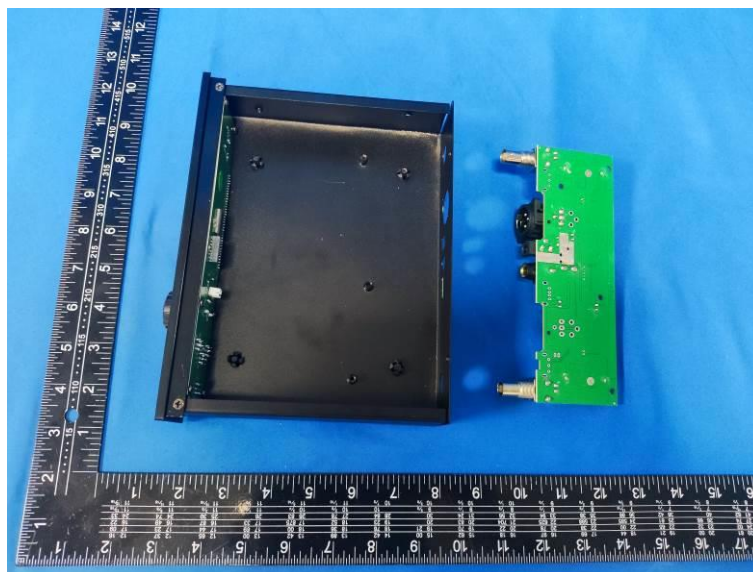
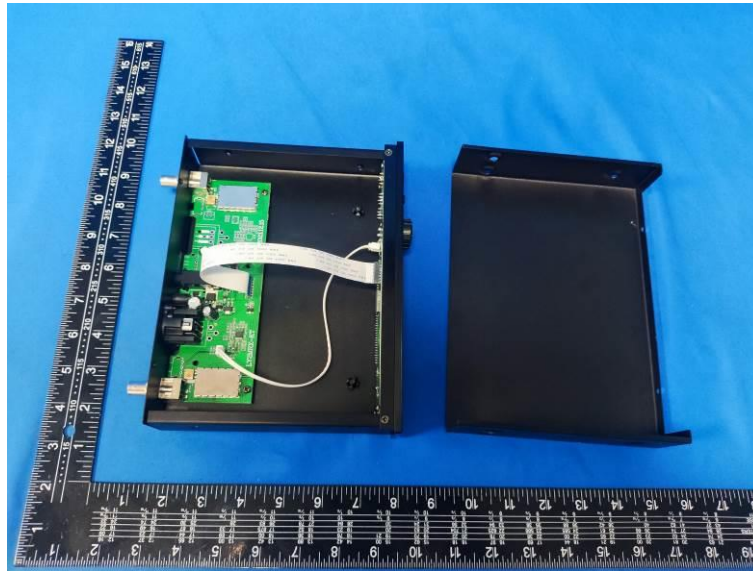

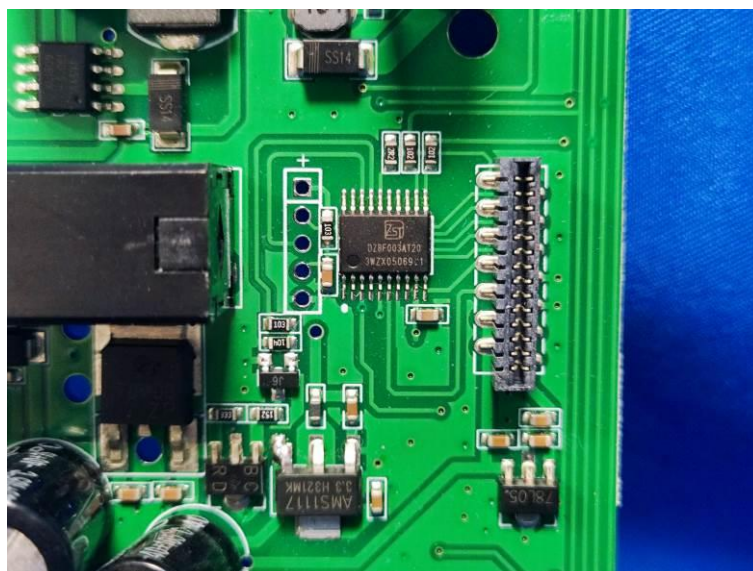
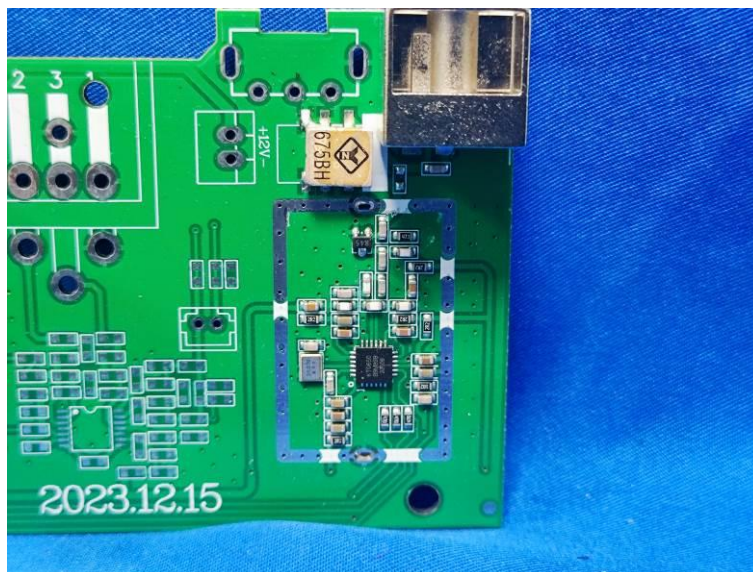
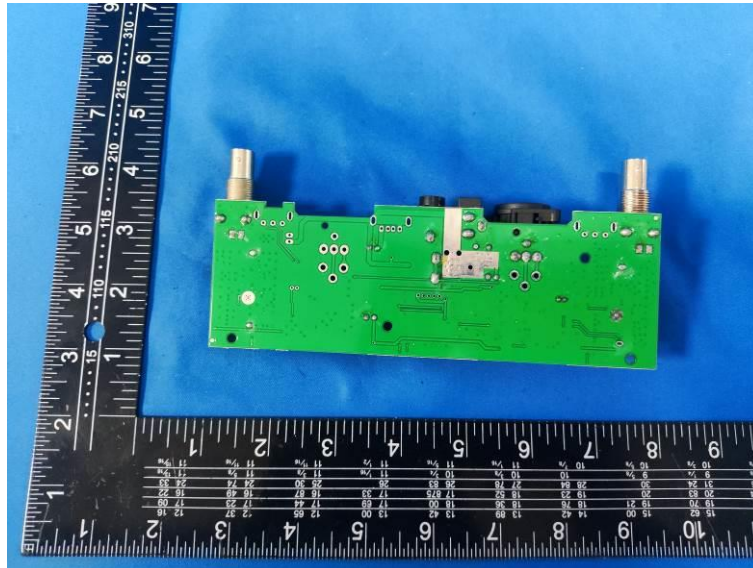

.....End of Report.....